



# Hardware Manual

## intelligent Touch Controller



Model

DCS601C51

MAC ADDRESS



- Thank you for purchasing intelligent Touch Controller.
- This operation manual contains notes for safe use of the product.  
For correct use, be sure to read this manual carefully before use.  
Store this manual close at hand so that it can be referred to as required.

### Before use

#### Safety Instructions

Be sure to follow the instructions below ..	1
System Overview .....	3
Part Names and Functions .....	4

Before use

### Maintenance

Precautions .....	6
Maintenance	
LCD Maintenance .....	7
When Leaving the Product	
Turned OFF for a Long Time .....	7
Troubleshooting .....	8

Maintenance



### For Your Information

Options .....	12
Specification .....	13
After-sales Service .....	14





For Your Information

### Read the manual carefully in advance for correct use

- Instructions given here are classified into the following two categories.  
Instructions in both categories are important for safety and must be duly followed.

 <b>Warning</b>	Failure to follow the instruction may lead to serious consequences including death or serious injury.
 <b>Caution</b>	Failure to follow the instruction may cause injury or material damage, which, in some cases, leads to serious consequences.

- The symbol given in the manual shows the following:

	Do not attempt to do things described in the instruction.		Be sure to follow the instruction.
	Be sure to provide grounding as required.		Absolutely avoid exposing the unit to water.

## **Warning** Notes on use for users

- When any abnormality (such as burnt smell) is generated, turn the power OFF and contact the dealer you purchased the product from.

Continuing to operate with the abnormality left unattended may cause failure, electric shock or fire.

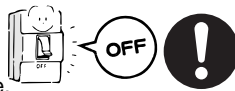

- For transferring or reinstallation, contact the dealer you purchased the product from.

Failure to install properly may cause water leak, electric shock or fire.



- For remodelling or repair, contact the dealer you purchased the product from.

Failure to remodel or repair properly may cause water leak, electric shock or fire.



- Do not touch the inside of the controller.

Do not remove the front panel. Touching the inside is dangerous and may cause failure. For inspection and adjustment of the inside of the controller, contact the dealer you purchased the product from.

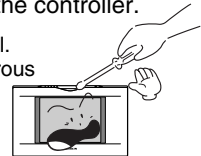

## **Caution** Notes on use for users

- Be sure to operate with the touch pen provided.

Failure to follow the instruction may lead to damage or failure.



- Do not wash the controller with water.

Washing may lead to electric shock.



No exposure to water allowed!

- To clean, be sure to stop operation and turn the power OFF.

Failure to follow the instruction may lead to electric shock or injury.



- Do not install the controller in a place subject to water.

Water in the device may lead to electrical leak and failure in the electronic components inside.



No exposure to water allowed!

- Do not install in a place subject to flammable gas.

Leakage of gas resulting in accumulation around the unit may lead to ignition.



- Be sure to provide grounding.

Do not connect the grounding wire to any gas pipe, water pipe, lightning rod or telephone grounding. Inappropriate grounding may lead to electric shock.



- Do not install in a place subject to direct sunlight.

Failure to follow the instruction may lead to discoloring of the LCD that hinders proper display.

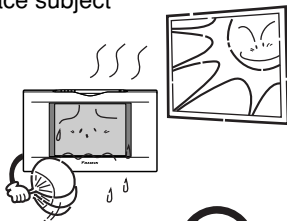

- Do not wipe the surface of the controller touch panel with benzene, thinner or chemically-treated dust cloth.

Failure to follow the instruction may lead to discoloring or peeling of the paint. Any soiling must be wiped off with a piece of cloth soaked in a diluted neutral detergent and wrung sufficiently. Wipe again with a dry piece of cloth.

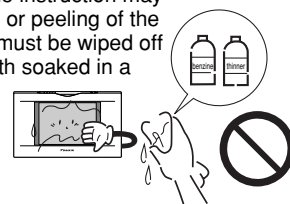

# System Overview

This intelligent Touch Controller is capable of controlling/monitoring up to 64 groups of indoor units (hereafter "groups").

The main functions of the intelligent Touch Controller include:

1. Collective starting/stopping of operation of the indoor units connected to the intelligent Touch Controller.
2. Starting/stopping of operation, temperature setting, switching between temperature control modes and enabling/disabling of operation with the hand-held remote control by zone or group.
3. Scheduling by zone or group.
4. Monitoring of the operation status by zone or group.
5. Display of the air conditioner operation history.
6. Compulsory contact stop input from the central monitoring panel (non-voltage, normally-open contact).
7. Power distribution of the air conditioners. (With the optional DCS002C51)
8. Control and Monitoring of air conditioner with personal computer by the Controller (with the optional DCS004A51).

\* A group of indoor units include:

- ① One indoor unit without a remote control.
- ② One indoor unit controlled with one or two remote controls.

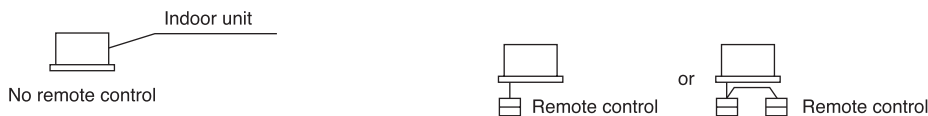

- ③ Up to 16 indoor units controlled with one or two remote controls.



\* Zone control with the intelligent Touch Controller

\* Zone control, which allows collective settings for more than one group, is available with the intelligent Touch Controller, which facilitates the setting operations.

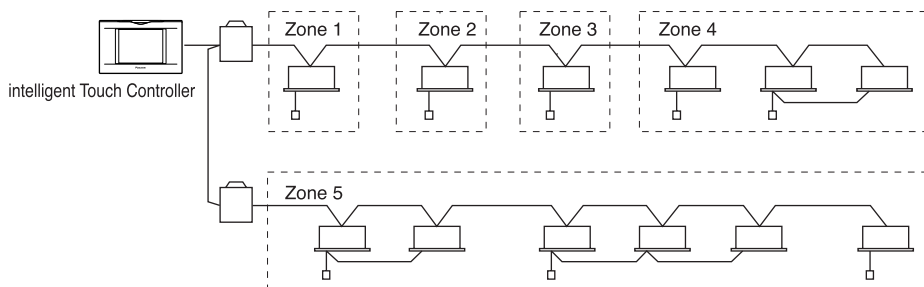

- One setting makes the same setting for all of the units in one zone.
- Up to 128 zones can be set with one intelligent Touch Controller. (The maximum number of groups in one zone is 64.)
- Groups can be zoned at will with the intelligent Touch Controller.
- Units in one group can be divided into more than one zone.

## Front and Side View



### PCMCIA Card Slot

Used when using the optional Power Proportional Distribution (DCS002C51) or updating the intelligent Touch Controller software to a newer version.



### Color LCD with Touch Panel

Provides a display for monitoring and operation.  
Be sure to use the touch pen provided for operation.

### Touch Pen

Use the touch pen for operation.  
Be sure to use the touch pen for operation.  
Use caution not to lose the touch pen.

(When the pen is lost, contact the dealer you purchased the product from.)

### Note

- Be sure to use the touch pen for operation of the touch panel of the intelligent Touch Controller. Operating with an object other than the touch pen provided may cause damage and failure.

Before use

# Terminals on the Back of intelligent Touch Controller

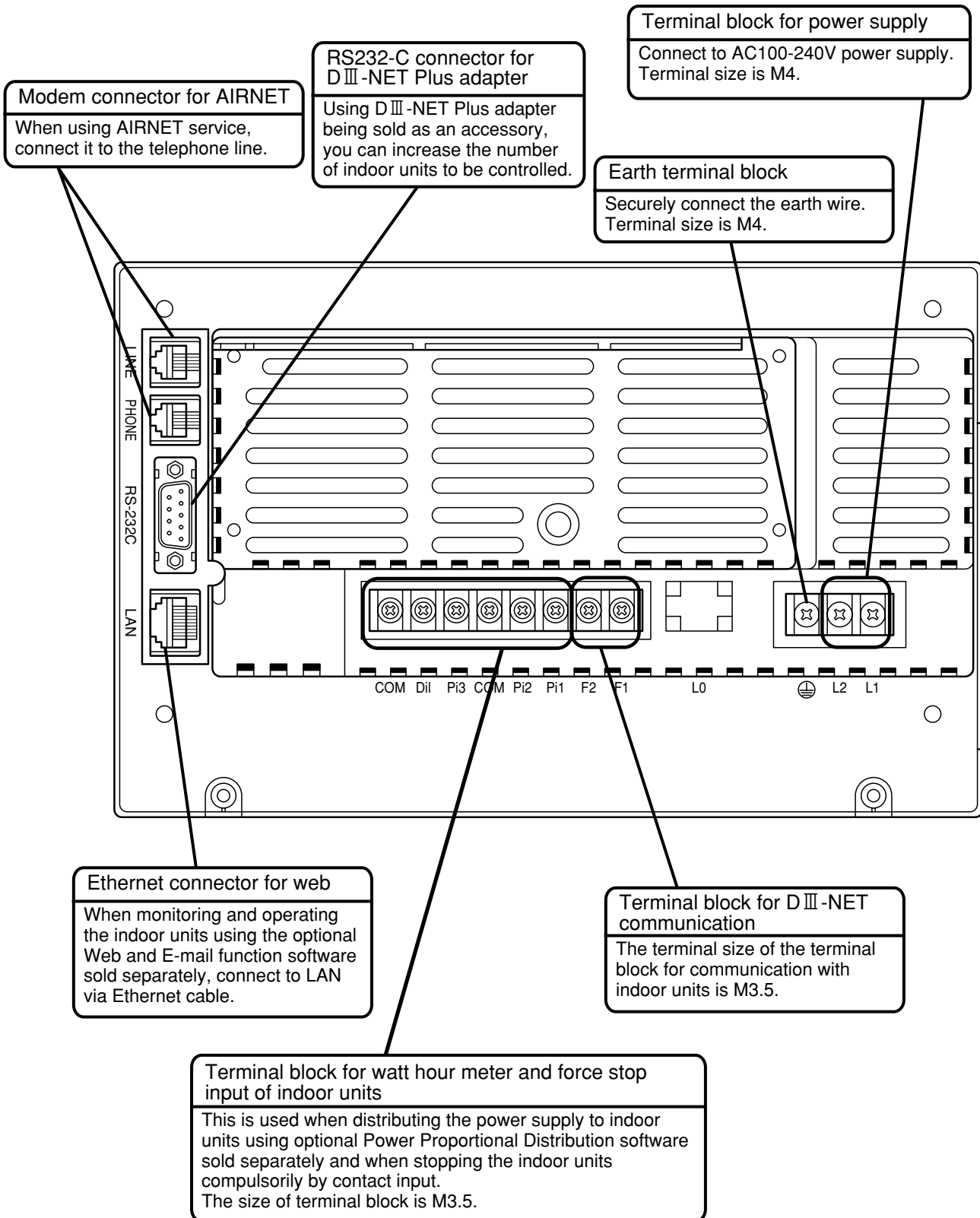

## Internal Battery Enable(ON)/Disable(OFF)Switch

The intelligent Touch Controller is equipped with internal batteries in order to run the clock during blackouts as well as to save data during blackouts when using the optional Power Proportional Distribution. The batteries can be enabled and disabled using the switches shown in the figure below.

**The clock and Power Proportional Distribution will not function properly when a blackout occurs if this switch is turned to 「OFF」.**

**The switches are turned to 「ON」 when the unit is installed. Do not touch them unless the power has been turned off for a long time. (See the next page for details on what to do if the power has been off for long periods of time.)**

### <Location and Setting of Switches>

As shown in the figure, set the battery switch on the left side of this controller to “OFF” (switch knob upper side) or “ON” (switch knob lower side), using a precision minus(-) screwdriver. (Turning this switch OFF does not erase the settings for groups, zones or schedule.)

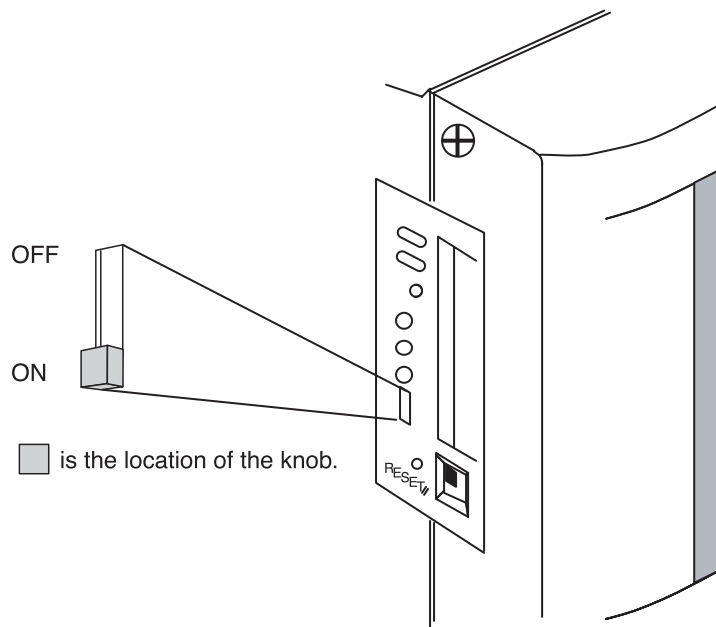

### Note

- Do not touch other switches.
- Avoid turning the switch ON and OFF with excessive force; otherwise such operation may lead to parts damage and failure.

## LCD Maintenance

- When the surface of the LCD or the main unit of the intelligent Touch Controller is soiled, wipe the soil off with a piece of cloth soaked in a diluted neutral detergent and wrung sufficiently.

Note

- Do not use thinner, organic solvent, strongly acid solution, etc.  
The print may fade or wear out and discolor.
- Forced rubbing with hard cloth may cause damage to the liquid crystal display unit.  
Remove stains, always using a soft waste cloth.
- If the unit is stored with water droplets and stains sticking to the liquid crystal display unit, a blot may be made and the coating may come off.

## When Leaving the Product Turned OFF for a Long Time

When you leave the intelligent Touch Controller turned OFF for a long time (6 months or longer), turn the switch OFF to maintain the battery.

- The intelligent Touch Controller has a built-in battery for operating the clock in power failure.  
The battery mentioned above is for power failure only and it may be completely discharged if no power is provided for a long time.  
(The capacity is worth about 2 years of in total if no power is supplied.)
- To use the intelligent Touch Controller again, turn the switch ON.

[Setting the switch]

As shown in the figure, set the battery switch on the left side of this controller to “OFF” (switch knob upper side) or “ON” (switch knob lower side), using a precision minus(-) screwdriver.  
(Turning this switch OFF does not erase the settings for groups, zones or schedule.)

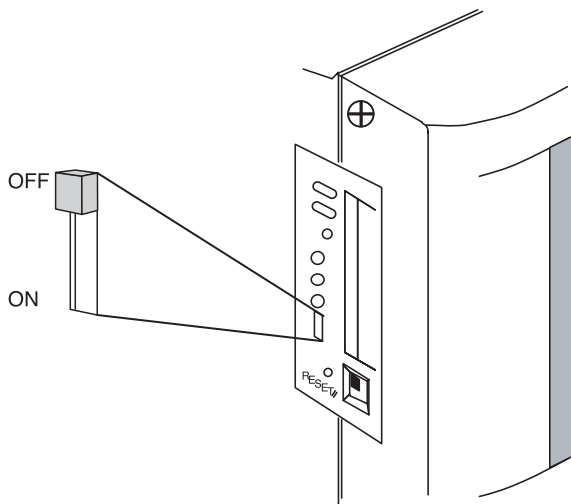

■ is the location of the knob.

Note

- Do not touch other switches.
- Avoid turning the switch ON and OFF with excessive force; otherwise such operation may lead to parts damage and failure.

Caution

If electric components in the intelligent Touch Controller are charged with static electricity, it may cause failure.  
Be sure to discharge the static electricity accumulated in your body before attempting any operation.  
To discharge yourself, touch a grounded metal object (control panel, etc.).

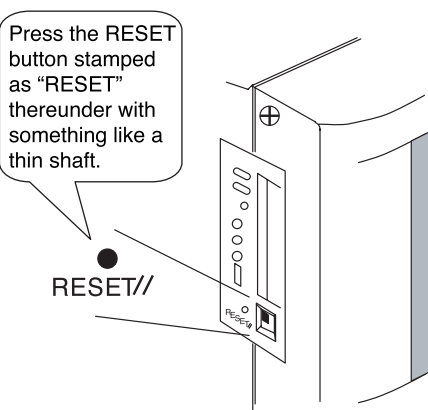

## Before Having the Product Serviced

Item	Description and Corrective Action
The display of the intelligent Touch Controller has gone out.	When Backlight Auto OFF is set for Backlight Setup of the intelligent Touch Controller, the light goes out if the screen is left untouched for a certain time. Touch the screen with the pen provided. The display comes back on.
The backlight does not go out when Backlight auto OFF is set.	Backlight Auto OFF is a function to automatically turn the backlight OFF if it is left untouched for a certain time. If the display is 「Set/Prop」 「System Setup」 etc., the light does not go out automatically.
The intelligent Touch Controller cannot be operated or monitoring is not available.	<p>Press and hold down the reset button on the left screen of the intelligent Touch controller for 5 seconds. Pressing this switch initialize the intelligent Touch Controller. (Pressing this switch does not erase the settings for groups, zones or schedule.)</p> <div style="display: flex; align-items: center;"> <div style="border: 1px solid black; border-radius: 10px; padding: 5px; margin-right: 20px;"> <p>Press the RESET button stamped as "RESET" thereunder with something like a thin shaft.</p> </div>  <div style="margin-left: 20px;"> <p><b>Note</b></p> <ul style="list-style-type: none"> <li>● Do not touch other switches.</li> <li>● Avoid turning the switch ON and OFF with excessive force; otherwise such operation may lead to parts damage and failure.</li> </ul> </div> </div> <p style="text-align: center;">intelligent Touch Controller</p> <div style="border: 1px solid black; border-radius: 10px; padding: 10px; margin-top: 10px;"> <p><b>Caution</b> ⚠ If electric components in the intelligent Touch Controller are charged with static electricity, it may cause failure. Be sure to discharge the static electricity accumulated in your body before attempting any operation. To discharge yourself, touch a grounded metal object (control panel, etc.).</p> </div>

Item	Description and Corrective Action
On the Monitoring screen, buzzer sounds when an area not allocated for a button for operation is pressed.	The intelligent Touch Controller is designed in such a way that the buzzer sounds when any part of the screen is pressed. It is normal.
Something is wrong with the buzzer sound (the sound breaks up, etc.)	The buzzer sound may occasionally break up when the load on the CPU is particularly large, but this is not a problem.
The screen flickers at a regular interval.	While the Monitoring screen is shown, the screen is updated every 3 seconds to show the latest status of air conditioners. The screen may look flickering when the update is made. It is normal.
Touching the screen of the intelligent Touch Controller does not change the display soon.	Updating of the display may take some time depending on the communication status with the air conditioners connected. Update is completed in a few seconds.
Some dots of LCD are never illuminated.	There may be found some dots that are never illuminated or always illuminated on a certain part of the LCD of the intelligent Touch Controller. It is normal. The LCD may inherently generate unevenness due to change of temperature, which is normal.
An air conditioner to be connected to the intelligent Touch Controller has been added but the added air conditioner cannot be monitored on the Monitoring screen of the intelligent Touch Controller.	When adding an air conditioner to be connected to the intelligent Touch Controller, trial running of the intelligent Touch Controller, as well as of the air conditioner, is required. ( When trial running of the intelligent Touch Controller has not been performed, contact our representative. )

## Emergency Procedure for intelligent Touch Controller Failure

Item	Description and Corrective Action
<p>Failure occurs in the intelligent Touch Controller while the remote control is disabled with the intelligent Touch Controller and start/stop setting, etc. of air conditioners cannot be made.</p>	<p>As a temporary measure before our service personnel investigates into the problem, turn OFF the power supply breaker of the intelligent Touch Controller. This allows all kinds of operation with the remote control of air conditioners in about 5 minutes. (When there is any other central management device, turn the power OFF for all of the devices. )</p>

When it is desired to adjust screen brightness, contrast and buzzer sound level

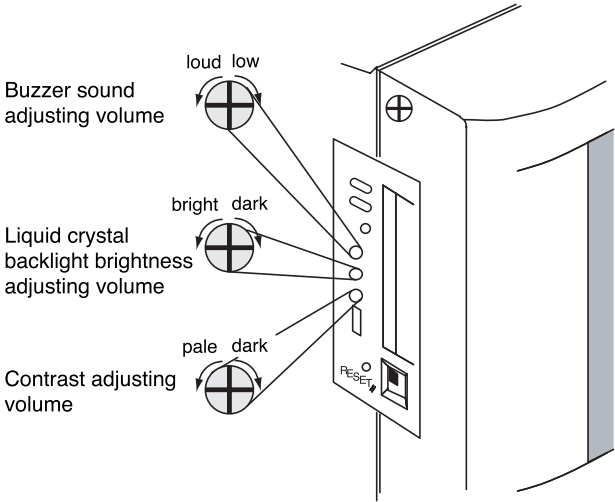
Item	Description and Corrective Action
<p>Screen brightness, contrast and buzzer sound adjustment is desired.</p>	<p>The screen brightness, contrast and buzzer sound level are factory adjusted properly before shipment, but in case where the screen is hard to see and the buzzer is hard to hear, for example, according to the actual installation condition and usage, the screen brightness, contrast and buzzer sound level can be adjusted by the following method.</p> <p>[Adjustment Method]            Adjust the volume (variable resistor) on the left side of the intelligent Touch controller with a Phillips head screwdriver while checking each level.            The buzzer sound, screen brightness and screen contrast volume switches are located in sequence from the top as shown below.</p>  <p><b>Note</b></p> <ul style="list-style-type: none"> <li>● Since each volume is a precision component part, do not turn the volume switch with excessive force. It should be noted that a fault is caused to the switch.</li> <li>● Do not touch other switches.            (The buzzer sound volume and liquid crystal backlight brightness can be adjusted with the volume switch described above; normally, however, no such adjustment is required.)</li> </ul> <p><b>Caution</b></p> <p>If electric components in the intelligent Touch Controller are charged with static electricity, it may cause failure. Be sure to discharge the static electricity accumulated in your body before attempting any operation. To discharge yourself, touch a grounded metal object (control panel, etc.).</p>

Connecting Unification adaptor allows using the contact for normal and abnormal operation signal and collective start/stop with a contact. For details, contact the vendor you purchased the product from. Also, by connecting D III NET-plus adaptor, it is possible to operate and monitor the indoor units of 64 groups (intelligent Touch Controller plus D III NET – plus adapter–128 groups in total) additionally.

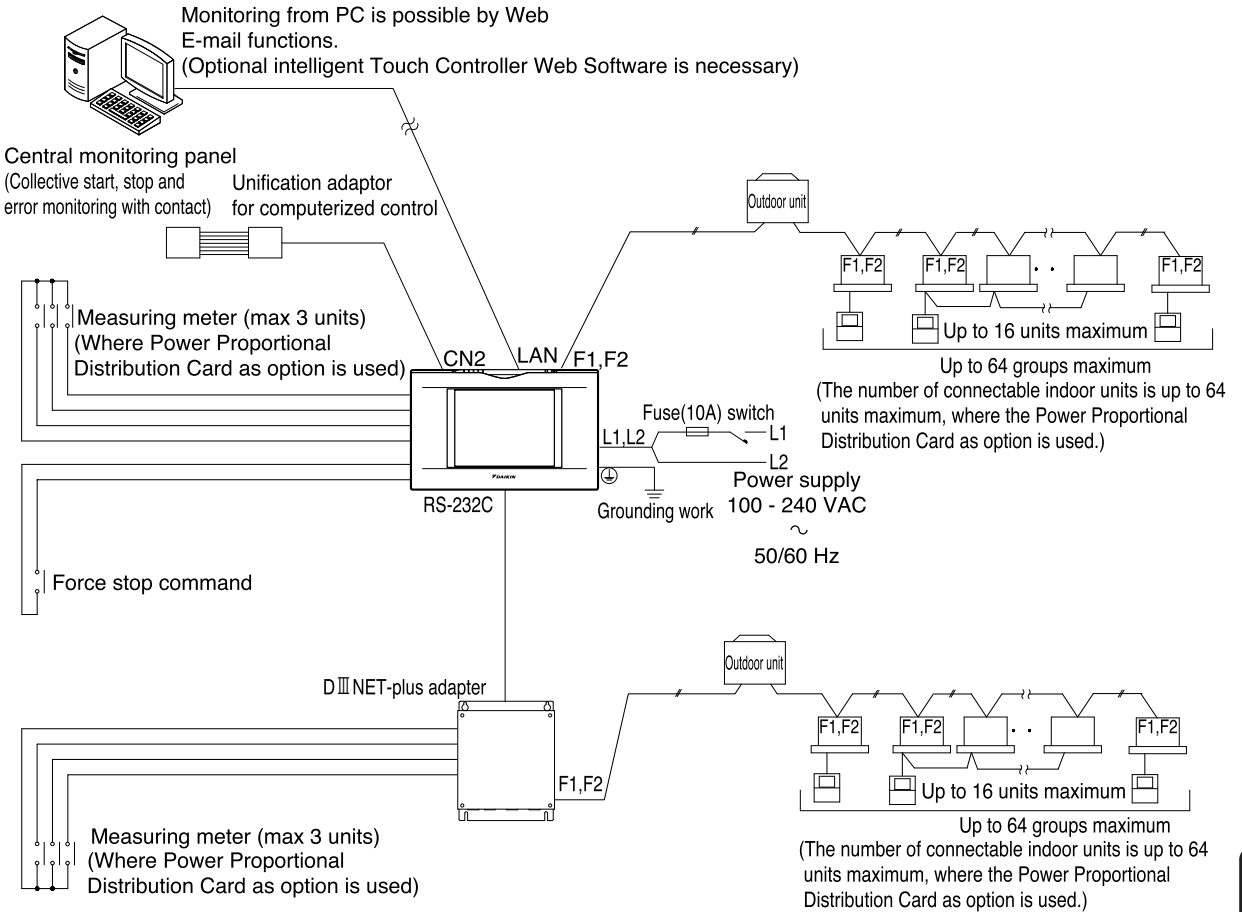

# Specification

## Specification

Power	AC100 - 240V 50/60Hz
Power consumption	10 W maximum
Force stop input	Normally-open contact Contact current approximately 10 mA
Size	230 × 147 × 107 (W × H × D)
Mass	1.2kg

## Dimensions

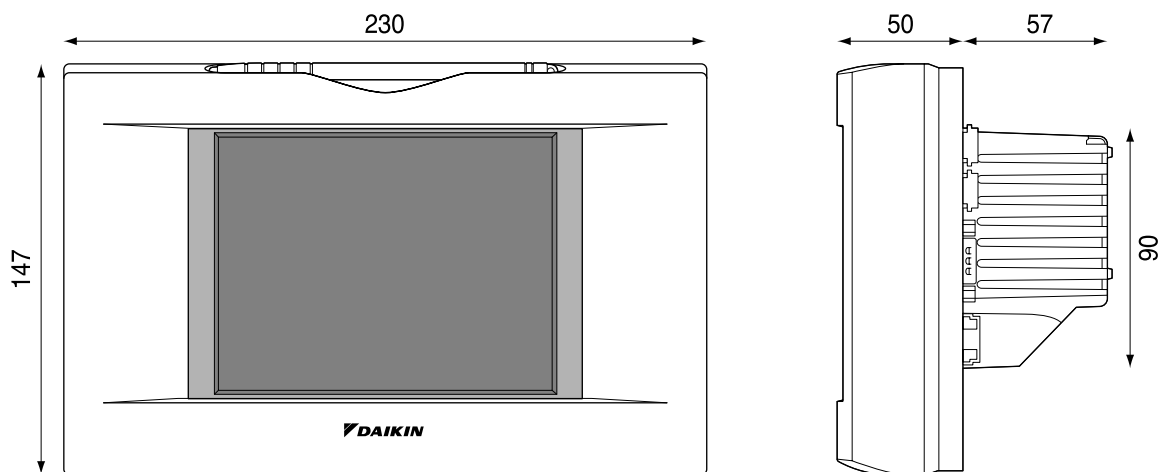

The specification and appearance of the product may be modified for improvement without prior notice.

## After-sales Service

---

- To have the product repaired, prepare the following information

- Model
- Date of installation
- Circumstances - as detailed as possible
- Address, name, phone number

- **Transfer**

Transfer requires professional technique. Be sure to contact the vendor you purchased the product from or service station.

The customer will be charged for the expense required for transfer work.

- **Repair after the guarantee period for free repair**

Contact the vendor. When the functions can be maintained by repair, the product will be repaired according to the request and the customer will be charged.

(Guarantee period ... one year from the date of installation)

- **Questions**

For after-sales service, contact the vendor you purchased the product from or the nearest service station.

**DAIKIN INDUSTRIES, LTD.**

Head office:

Umeda Center Bldg., 4-12, Nakazaki-Nishi 2-chome,  
Kita-ku, Osaka, 530-8323 Japan

Tokyo office:

JR Shinagawa East Bldg., 18-1, Konan  
2-chome, Minato-ku, Tokyo, 108-0075 Japan

**DAIKIN EUROPE NV**

Zandvoordestraat 300, B-8400 Oostende, Belgium