

OPERATION MANUAL

Power Proportional Distribution Software

MODEL
DCS002C51

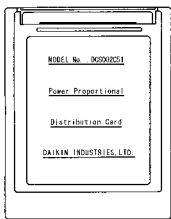

The above intelligent Touch
Controller is available separately.

Thanks for your having purchased our product, Power Proportional Distribution Card.
This operation manual contains notes for safe use of the product.

For correct use, be sure to read this manual carefully before use.

When you have read this manual, be sure to store it in a place where the operator can conveniently refer to at anytime.

In case of personnel change, be sure to give the manual to the new operator.

CONTENTS

- 1. SAFETY CONSIDERATIONS 1
- 2. FUNCTIONS AND OUTLINE 2
- 3. PREPARATION 3
- 4. SIMPLIFIED CHART 3
- 5. INITIAL SETUP 3
- 6. POWER PROPORTIONAL DISTRIBUTION REPORT
OUTPUT PROCEDURES 5
- 7. HOW TO OUTPUT POWER PROPORTIONAL
DISTRIBUTION REPORT 5
- 8. TROUBLESHOOTING 9
- 9. AFTER-SALES SERVICE 10

1. SAFETY CONSIDERATIONS

Please read these "SAFETY CONSIDERATIONS" carefully before installing air conditioning equipment and be sure to install it correctly.
After completing the installation, make sure that the unit operates properly during the start-up operation.
Please instruct the customer on how to operate the unit and keep it maintained.
Also, inform customers that they should store this installation manual along with the operation manual for future reference. This air conditioner comes under the term "appliances not accessible to the general public".

Meaning of warning, caution and note symbols.

 **WARNING** Indicates a potentially hazardous situation which, if not avoided, could result in death or serious injury.

 **CAUTION** Indicates a potentially hazardous situation which, if not avoided, may result in minor or moderate injury. It may also be used to alert against unsafe practices.

 **NOTE** Indicates situation that may result in equipment or property-damage-only accidents.

Keep these warning sheets handy so that you can refer to them if needed.

Also, if this equipment is transferred to a new user, make sure to hand over this operation manual to the new user.

WARNING

In order to avoid electric shock, fire or injury, or if you detect any abnormality such as smell of fire, turn off power and call your dealer for instructions.

Ask your dealer for installation of the air conditioner.
Incomplete installation performed by yourself may result in a water leakage, electric shock, and fire.

Ask your dealer for improvement, repair, and maintenance.
Incomplete improvement, repair, and maintenance may result in a water leakage, electric shock, and fire.

Improper installation or attachment of equipment or accessories could result in electric shock, short-circuit, leaks, fire or other damage to the equipment. Be sure only to use accessories made by Daikin which are specifically designed for use with the equipment and have them installed by a professional.

Ask your dealer to move and reinstall the air conditioner or the remote controller.

Incomplete installation may result in a water leakage, electric shock, and fire.

Never let the indoor unit or the remote controller get wet.
It may cause an electric shock or a fire.

Never use flammable spray such as hair spray, lacquer or paint near the unit.
It may cause a fire.

Never replace a fuse with that of wrong ampere ratings or other wires when a fuse blows out.

Use of wire or copper wire may cause the unit to break down or cause a fire.

Never inspect or service the unit by yourself.

Ask a qualified service person to perform this work.

Cut off all electric waves before maintenance.

Do not wash the air conditioner or the remote controller with excessive water.

Electric shock or fire may result.

Do not install the air conditioner or the remote controller at any place where flammable gas may leak out.

If the gas leaks out and stays around the air conditioner, a fire may break out.

Do not touch the switch with wet fingers.

Touching a switch with wet fingers can cause electric shock.

CISPR 22 Class A Warning:

This is a class A product. In a domestic environment this product may cause radio interference in which case the user may be required to take adequate measures.

CAUTION

After a long use, check the unit stand and fitting for damage.

If they are left in a damaged condition, the unit may fall and result in injury.

Do not allow a child to mount on the unit or avoid placing any object on it.

Falling or tumbling may result in injury.

Do not let children play on and around the unit.

If they touch the unit carelessly, it may result in injury.

Do not place a flower vase and anything containing water.

Water may enter the unit, causing an electric shock or fire.

Never touch the internal parts of the controller.

Do not remove the front panel. Some parts inside are dangerous to touch, and a machine trouble may happen.

For checking and adjusting the internal parts, contact your dealer.

Avoid placing the controller in a spot splashed with water.

Water coming inside the machine may cause an electric leak or may damage the internal electronic parts.

Do not operate the air conditioner when using a room fumigation - type insecticide.

Failure to observe could cause the chemicals to become deposited in the unit, which could endanger the health of those who are hypersensitive to chemicals.

Safely dispose of the packing materials.

Packing materials, such as nails and other metal or wooden parts, may cause stabs or other injuries. Tear apart and throw away plastic packaging bags so that children will not play with them. If children play with a plastic bag which was not torn apart, they face the risk of suffocation.

Do not turn off the power immediately after stopping operation.

Always wait at least five minutes before turning off the power. Otherwise, water leakage and trouble may occur.

The appliance is not intended for use by young children or infirm persons without supervision.

The remote controller should be installed in such away that children cannot play with it.

Use the card provided in the same package.

NOTE

Never press the button of the remote controller with a hard, pointed object.

The remote controller may be damaged.

Never pull or twist the electric wire of the remote controller.

It may cause the unit to malfunction.

Do not place the controller exposed to direct sunlight.

The LCD display may get discolored, failing to display the data.

Do not wipe the controller operation panel with benzene, thinner, chemical dustcloth, etc.

The panel may get discolored or the coating peeled off. If it is heavily dirty, soak a cloth in water-diluted neutral detergent, squeeze it well and wipe the panel clean. And wipe it with another dry cloth.

Dismantling of the unit, treatment of the refrigerant, oil and eventual other parts, should be done in accordance with the relevant local and national regulations.

2. FUNCTIONS AND OUTLINE

Power Proportional Distribution Card, in combination with an existing intelligent Touch Controller, enables to proportionally calculate and display electricity amount used by air conditioner per indoor unit.

[Main Functions]

Power proportional distribution results data can be saved for 12 months. (max. 12 months and 30 days)

- Per intelligent Touch Controller, power proportional distribution can be calculated for 64 indoor units at maximum.
- When DIII-NET Plus Adaptor is connected, power proportional distribution can be calculated for more 64 indoor units at maximum (a total of 128).
- 3 Electric power meters at maximum can be connected to an intelligent Touch Controller.
- When DIII-NET Plus Adaptor is connected, more 3 Electric power meters at maximum (a total of 6) can be connected.
- Power proportion distribution results data can be saved into a PCMCIA card.

Data is saved CSV format generally applied to personal computers, so bills can be issued by use of a general purpose table calculation software package in easy manners. (A personal computer and a general purpose table calculation software package can be available separately.)

[Precautions]

This system calculates electricity consumptions by size of indoor units, run time, expansion valves open gap, suction rate and the number of pulses from the power meters installed at the Outdoor Units.

This method is not calculated by direct measurement alone.

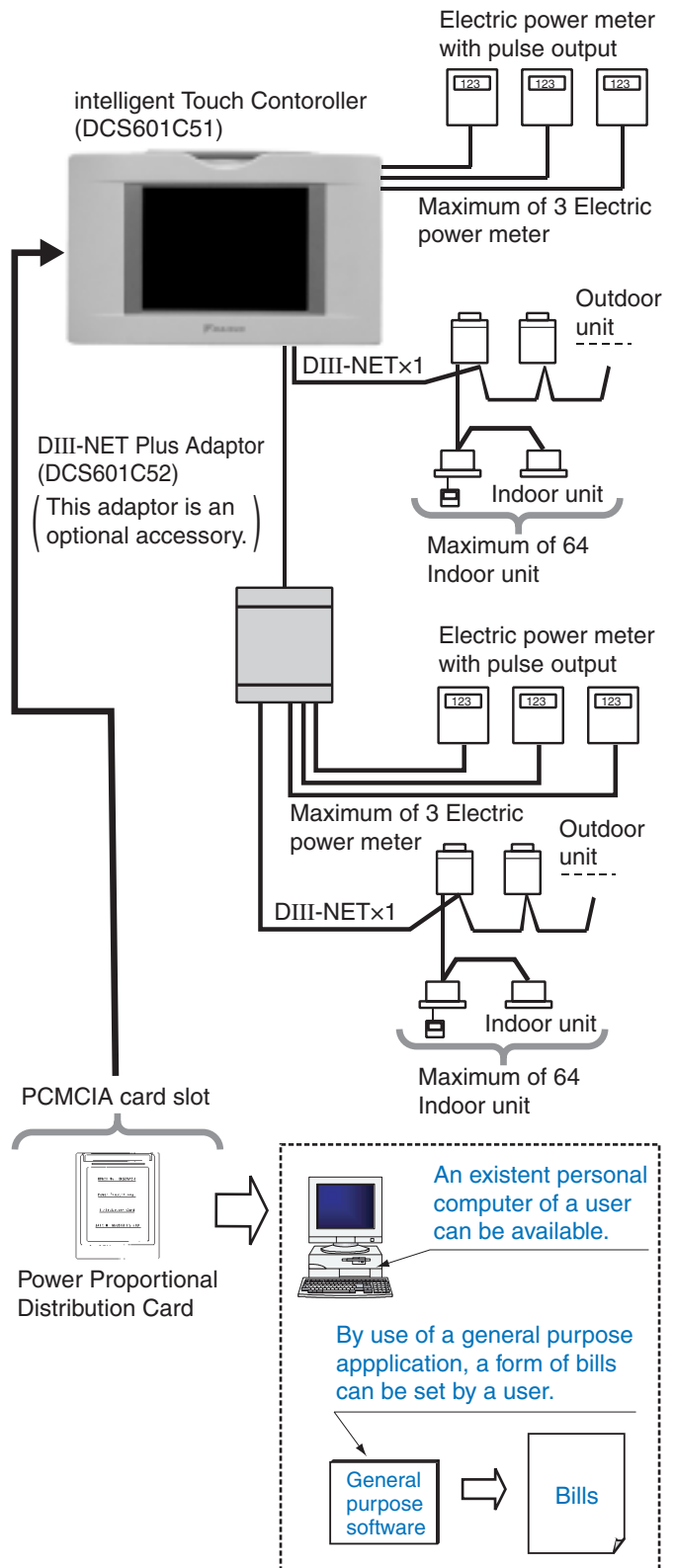

3. PREPARATION

3-1 Checking Attachments

Power Proportional Distribution Card includes the following attachments.

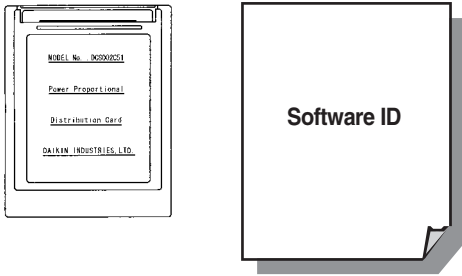

3-2 How to Connect

To activate the power proportional distribution function, it is necessary to set the program by use of the attached PCMCIA card and carry out a trial operation. Before use, consult your supplier.

4. SIMPLIFIED CHART

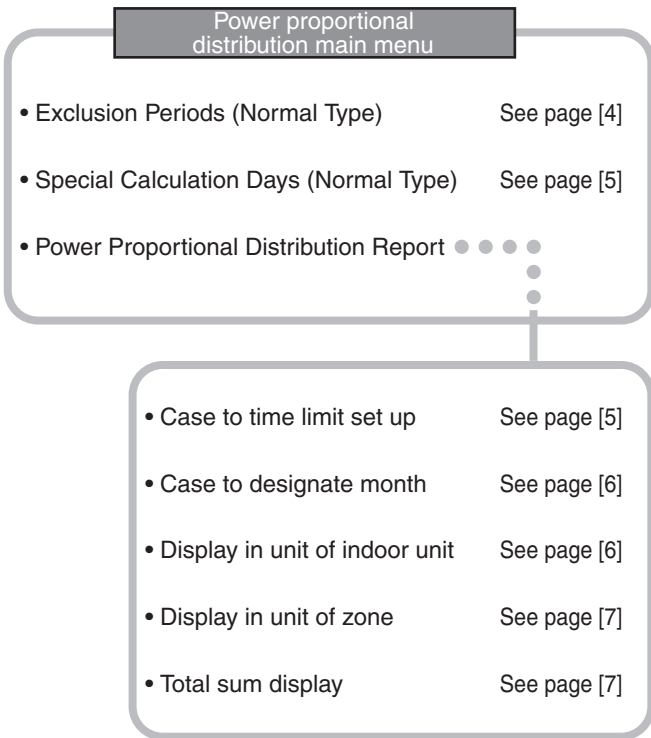

CAUTION
As for how to set current clock time, refer to the manual attached to intelligent Touch Controller.

5. INITIAL SETUP

5-1 Power Proportional Distribution Main Menu

Settings of power proportional distribution is made via the system setup menu.

To display the system setup menu, press the S button at the bottom on the screen.

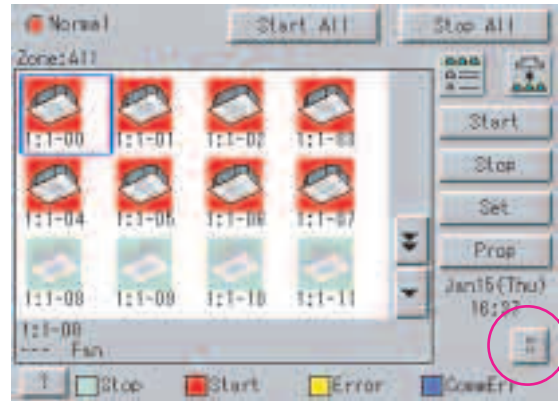

Press S button of the fundamental screen.

When the S button is pressed, the screen shown below will appear. Press "Pwr Prp Dist" in the system setup menu to display it inverted, and then press Execute button.

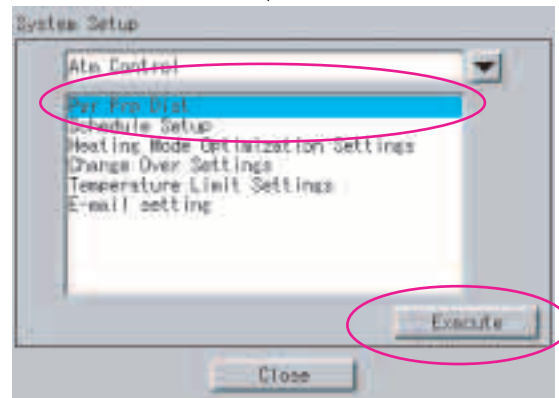

To set Special Calculation Days (Normal Type), press this button on the screen.

To set Exclusion Periods (Normal Type), press this button on the screen.

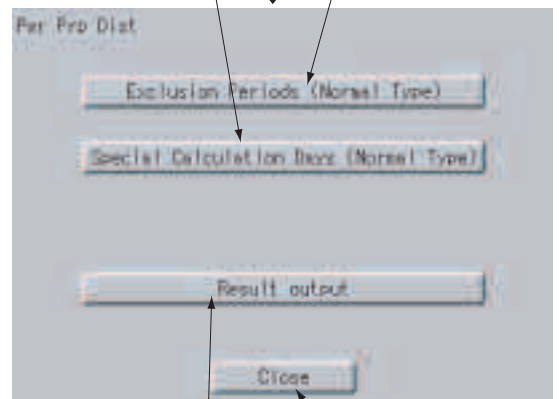

To set Power Proportional Distribution Report, press this button on the screen.

To get back to the previous screen, press this button on the screen.

NOTE

- Before initial setup, be sure to set the current clock time.

5-2 How to set Exclusion Periods (Normal Type)

This function is only for normal type, and exclusion periods where power proportional distribution calculation is not carried out and week days can be set. For example, it can be used when to collect fixed charges during day time in week days and carry out power proportional distribution calculation only for overtime work and holiday work. Time zone can be set per week day. By the way, this setup is of all systems, and it is impossible to make different settings in unit of zone.

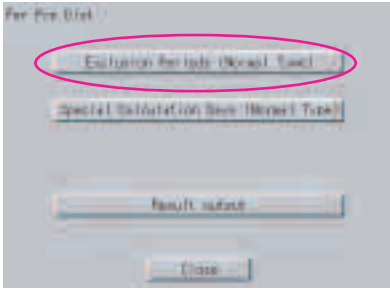

Press Exclusion Periods (Normal Type).

1. How to set Begin Time

Press Begin button of the week day you want to set, and set the begin time in exclusion periods where power proportional distribution calculation is not carried out.
*The numeric keyboard appears. Set Begin Time.

2. How to set End Time

Press End button of the week day you want to set, and set the end time in exclusion periods where power proportional distribution calculation is not carried out.
*The numeric keyboard appears. Set End Time.

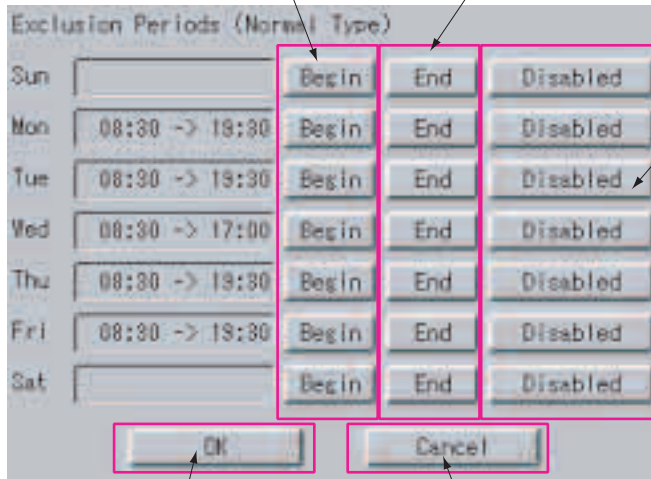

3. How to cancel time setting

When to cancel Exclusion Periods where power proportional distribution calculation is not carried out, press Disabled button.

4. When to end setup, press OK button.

5. When to cancel setup, press Cancel button. (Settings remain same as previous.)

[The numeric keyboard]

[How to set End Time]

When end time is set at 24:00 (at midnight), enter 00:00.



When Exclusion Periods is set in the above setup, the following setting contents appear.

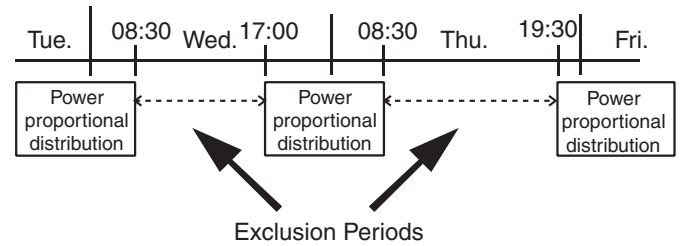

CAUTION

When end time is set over 24:00, it is considered it is set from 0:00 of the day.

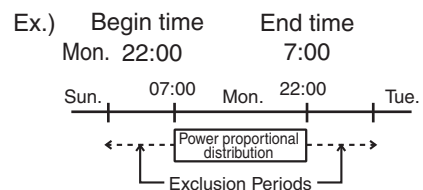

5-3 Special Calculation Days (Normal Type)

Even in the case where Exclusion Periods (Normal Type) is set, it is available to set a day when power proportional distribution calculation is specially carried out all the day (0:00 - 24:00). Setting is made for one year in unit of day. For example, it is used when to carry out power proportional distribution for all the day in irregular holidays.

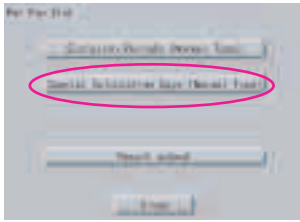

Press Special Calculation Days (Normal Type).

1. Select the month you want to set.
When << is pressed, the previous month is displayed.
When >> is pressed, the next month is displayed.

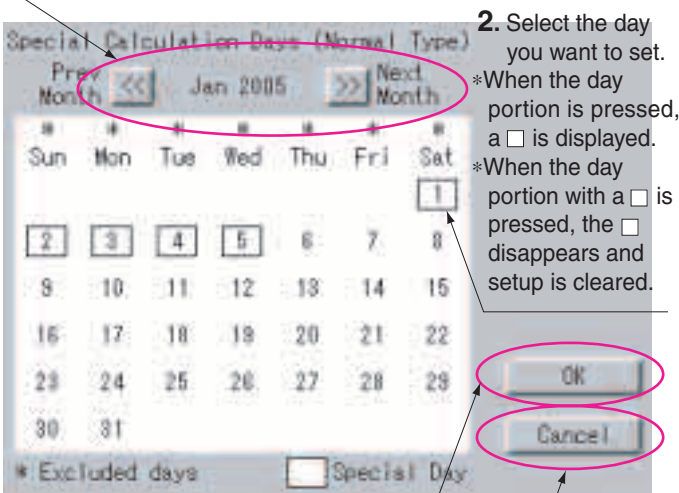

2. Select the day you want to set.
*When the day portion is pressed, a is displayed.
*When the day portion with a is pressed, the disappears and setup is cleared.

3. When to end setup, press OK button.
4. When to cancel setup, press Cancel button.
(Settings remain same as previous.)

6. POWER PROPORTIONAL DISTRIBUTION REPORT OUTPUT PROCEDURES

Here are descriptions of procedures to output monthly Power Proportional Distribution Report.

CAUTION

Monthly Power Proportional Distribution data will not be collected unless initial setup has been carried out.

[Screen Display Procedures]

1. Insert Power Proportional Distribution Card into PCMCIA card slot of intelligent Touch Controller.

2. Press S button in the default screen of intelligent Touch Controller.

3. Select the Pwr Prp Dist in the System Setup menu, and press Execute button.

4. Press Result output button in the Pwr Prp Dist menu.

5. Select either period designation or month designation.
In the case of period designation, enter calculation start day and calculation end day.
In the case of month designation, designate the calculation day since calculation is made in unit of month.

6. Press Execute button.

7. Power Proportional Distribution Report is displayed on the screen.

7. HOW TO OUTPUT POWER PROPORTIONAL DISTRIBUTION REPORT

7-1 Display of Power Proportional Distribution Report

There are 2 methods to display Power Proportional Distribution Report, the method to designate a period and the one to designate a month.

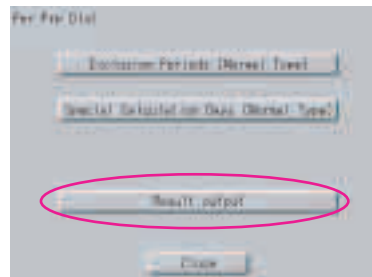

Press the Power Proportional Distribution Report button.

• Case to Time Limit Setup

In Time Limit Setup, the period for power proportional distribution calculation can be designated optionally. For example, it can be used when zone is changed in middle of a month and you want to see Power Proportional Distribution Report divided into the period before change and the period after change.

1. Select Time Limit Setup.
Press the portion.
When selected, the is displayed.
2. Designate the starting day of calculation period.
Set the starting day of proportional distribution calculation.
*The numeric keyboard appears, and set the starting day.

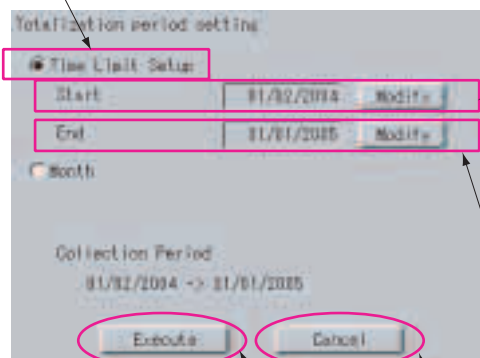

4. After setting period, press Execute button.

5. When to cancel setup, press Cancel button.
(Settings remain same as previous.)

3. Designate the ending day of calculation period.
Set the ending day of proportional distribution calculation.
*When Modify button is pressed, the numeric keyboard appears. Set the ending day.

• Case to designate month

In month designation, Power Proportional Distribution Report can be read in unit of one month. And by designating the calculation days, Power Proportional Distribution Report for a month from the designated calculation day of previous month to that of next month can be displayed.

1. Select Month.

Press the portion.
When selected, the is displayed.

2. Designate the Calculation Day.

When Modify button is pressed, the numeric keyboard appears.
Set the starting day of proportional distribution calculation.

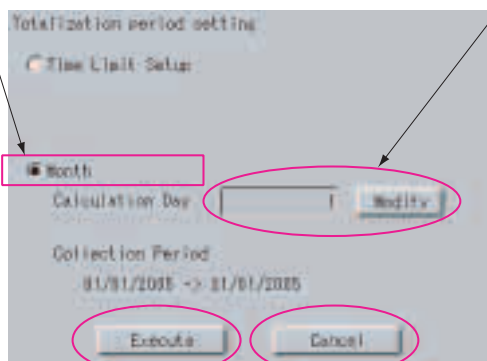

3. After setting period, press Execute button.

4. When to cancel setup, press Cancel button.
(Settings remain same as previous.)

Summary period is from 0:00 of the calculation day of one month before to 0:00 of that of this month.

Ex.) When the calculation day is set to "1" and the day of operating displays is 1 February, the power proportional distribution result of 1 to 31 January is summed up.

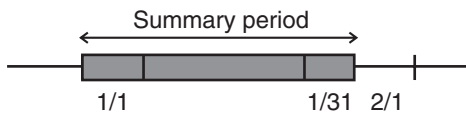

• Display of Power Proportional Distribution Report

After selecting either Time Limit Setup or Month, when Execute button is pressed, the following screen appears.



In case the power proportional distribution report is missing, the display indicates the list of missing data (day / month / year / time). The list indicates up to a maximum of 100 cases. If the missing data exceed 100 cases, the list indicates only the first 100 cases. If OK button is pressed, the display indicates the power proportional distribution report.

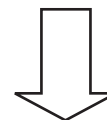
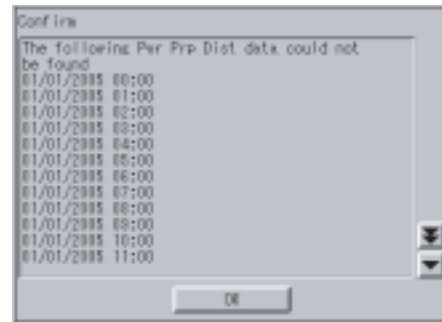

Display of Power Proportional Distribution Report

• Display in unit of indoor unit

1. When to display Power Proportional Distribution Report per indoor unit, select In/Unit.

Distribution Report per indoor unit, select In/Unit.
*Press the portion.
When selected, it turns to .

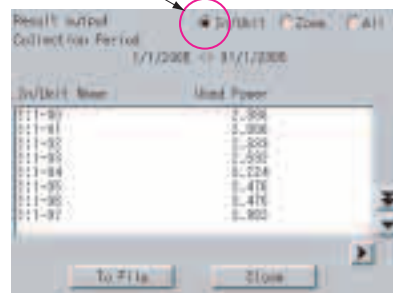

[Display contents explanation]

[Used Power]

In/Unit Name	Used Power
I-01	702.915

[Cautions]

Display of In/Unit Name

1:1-00 ~ 1:4-15 display indoor units connected to intelligent Touch Controller (DCS601C51).

2:1-00 ~ 2:4-15 display indoor units connected to DIII-NET Plus Adaptor (DCS601A52, Optional accessory).

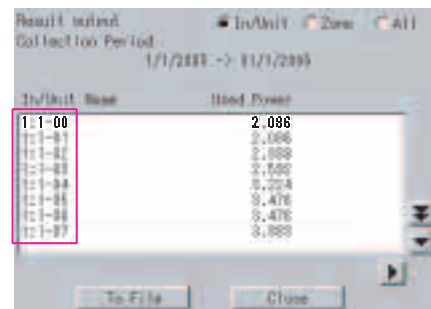

• Display in unit of zone

When Zone is selected, the total of Power Proportional Distribution Report of indoor units registered in zone is displayed.

1. When to display Power Proportional Distribution Report per zone, select the Zone.
*Press the portion.
When selected, it turns to .

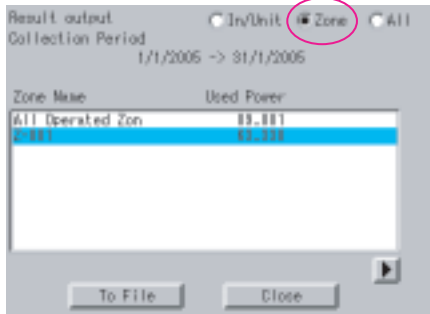

• Total sum display

When All is selected, the total of Power Proportional Distribution Report of all the indoor units is displayed.

1. When to display the total of Power Proportional Distribution Report of all the indoor units, select All.
*Press the portion.
When selected, it turns to .

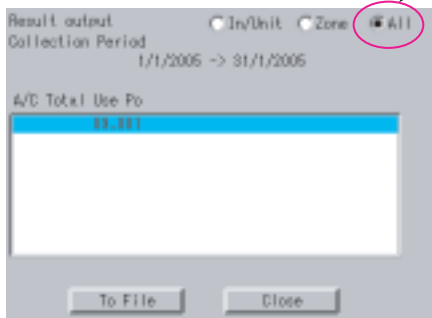

Insert the Power Proportional Distribution Card all the way into the insertion mouth on the left-hand side of the intelligent Touch Controller.
Check that the Power Proportional Distribution Card is seated in the right direction as shown below.

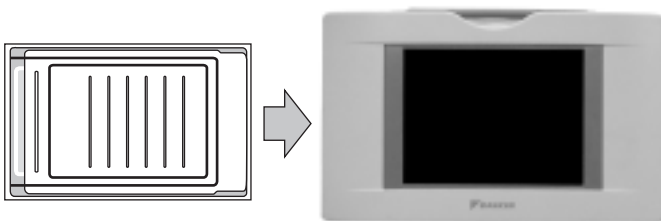
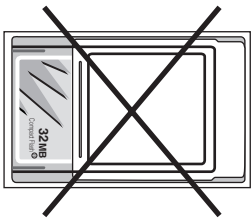

7-2 Saving Files

Power Proportional Distribution Report can be saved. When to print out Power Proportional Distribution Report, when to display electric power amount in unit of tenant, and when to convert electric power amount into charges, edit these files in your general purpose spread sheet software.

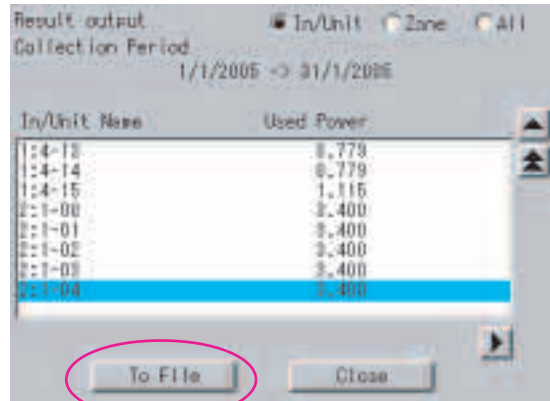

1. Insert the Power Proportional Distribution Card (PCMCIA card) into the intelligent Touch Controller, and press To File button.

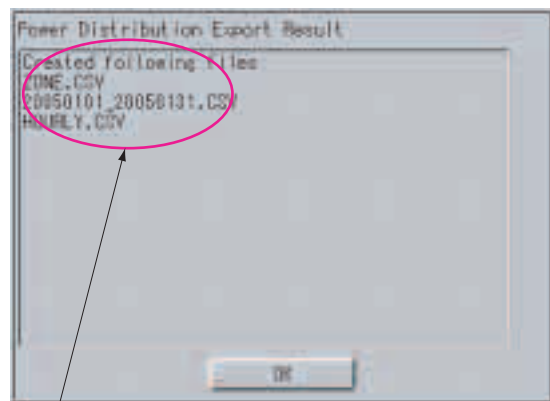
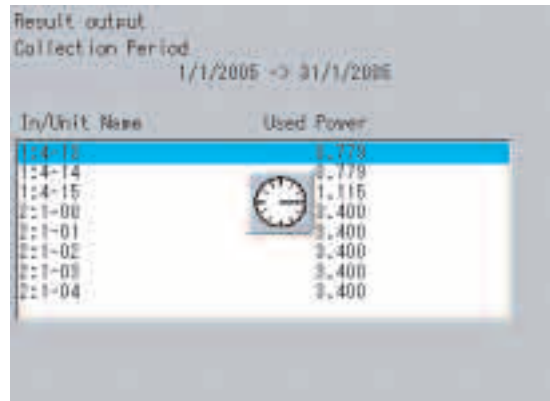

2. Power Proportional Distribution Report is saved into the PCMCIA card. And the saved file name is displayed.

[Cautions]

Display of In/Unit Name

1:1-00 ~ 1:4-15 display indoor units connected to intelligent Touch Controller (DCS601C51).

2:1-00 ~ 2:4-15 display indoor units connected to DIII-NET Plus Adaptor (DCS601A52, Optional accessory).

CAUTION

The minimum of 12 months to the maximum of 12 months and 30 days of the power proportional distribution results data can be retained.

When the month changes, the data of the previous month of the previous year will be zero cleared.

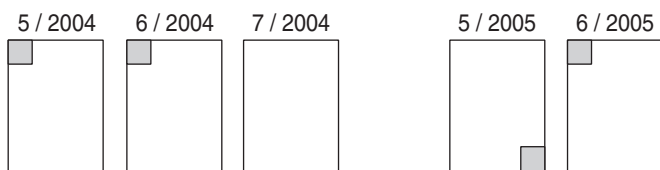

(Example)

- When reading the power proportional distribution results on 31 May 2005, the data from 1 May 2004 to 30 May 2005 can be read.
- When reading the power proportional distribution results on 1 June 2005, the data from 1 June 2004 to 31 May 2005 can be read.

7-3 File Format

When Power Proportional Distribution Report is saved, a zone information file, an electric power information file and detailed information file are created.

1. Zone information file

This contains zone name and information of air conditioners in the zone.

1. File name : ZONE.CSV

2. File format:

(Example)

```

Zone ID, Zone Name ← Index
0, " ' All" ← Zone ID, zone name
1, " ' Z-000"
2, " ' Z-001"
3, " ' Z-002"

zone ID, A/C Unit No ← One line space
0, 0 ← Zone ID, air conditioner number
0, 1
1, 2
1, 3
    
```

[Cautions]

Zone ID is automatically assigned. Do not change it.

2. Electric power information file

This file contains Power Proportional Distribution Report and information of air conditioners.

1. File name : YYYYMMDD_YYYYMMDD. CSV

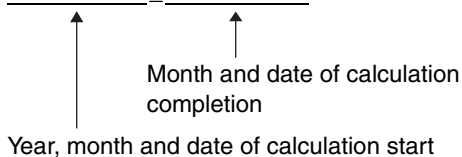

(Example)

When the data from 25 Oct. 2000 to 24 Nov. 2000 are totalled, the results are indicated as "20001025_20001124.CSV". If the file of the same name already exists, it overwrites.

2. File format :

(Example)

Start Date, Nb of Days, A/C Type, Undistributed Power Amount, Period Type
20050101,31,0,0,200501

A/C Unit No, In/Unit Name, HP Code, Daytime Used Pwr, Nighttime Used Pwr, Daytime Idle Pwr, Nighttime Idle Pwr,

```

0, "1:1-00", 38, 2459, 0, 0, 0
1, "1:1-01", 38, 2718, 0, 0, 0
2, "1:1-02", 38, 3105, 0, 0, 0
3, "1:1-03", 38, 3494, 0, 0, 0
4, "1:1-04", 38, 4141, 0, 0, 0

60, "1:4-12", 70, 489, 0, 0, 0
61, "1:4-13", 8c, 779, 0, 0, 0
62, "1:4-14", 2d, 779, 0, 0, 0
63, "1:4-15", 47, 1115, 0, 0, 0
64, "2:1-00", 38, 3400, 0, 0, 0

126, "2:4-14", 38, 3400, 0, 0, 0
127, "2:4-15", 38, 3400, 0, 0, 0
    
```

[Cautions]

Meaning of each data

- Start Date : The starting day of sum
- Nb of Days : Number of days of sum
- A/C Type : 0 fixed
- Undistributed Power Amount : 0 fixed
- Period Type : Period designation system (0 : Period designation system, Date : Month designation system)
- A/C Unit No : Number of indoor unit (0 ~ 63. 0 ~ 127 in case DIII-NET Plus Adaptor is connected.)
- In/Unit Name : Name of indoor unit
- HP Code : Horsepower of indoor unit
- Daytime Used Pwr : Power amount used
- Nighttime Used Pwr : Not used
- Daytime Idle Pwr : Electric power amount at stoppage (The amount is displayed, only when power proportional distribution calculation is not carried out at stoppage.)
- Nighttime Idle Pwr : Not used

3. Detailed information file

1. File name : HOURLY.CSV

If the detailed information already exists, it will overwrite.

Therefore, it is necessary to backup the data to a PC at every data output.

The data of the period designated by the power proportional distribution report (from 01:00 of the day the tabulation started to 0:00 of the next day the tabulation ended) are output. Regardless of whether the registration exists or not in the commissioning tool, the results of 64 (or 128) units of air conditioners are output.

2. File format:

(Example)

PPD Hourly Data (Wh)

Note:,Date and Time mean the calculation time of PPD.

,The value of 3:00 is a result between the calculation time just before 3:00 and 3:00.

Date,Time;'1:1-00,'1:1-01,'1:1-02,'1:1-03, --- , '1:4-15, '2:1-00,'2:1-01,'2:1-02, --- ,2:4-15

2005.1.1,1:00,21,20,15,21, --- ,15,21,20,15, --- ,15
 2005.1.1,2:00,22,20,17,22, --- ,17,22,20,17, --- ,17
 2005.1.1,3:00,20,24,19,20, --- ,19,20,24,19, --- ,19
 2005.1.1,4:00,20,21,16,20, --- ,16,20,21,16, --- ,16
 2005.1.1,5:00,21,24,18,21, --- ,18,21,24,18, --- ,18
 2005.1.1,6:00,20,24,18,20, --- ,18,20,24,18, --- ,18
 2005.1.1,7:00,20,24,20,20, --- ,20,20,24,20, --- ,20
 2005.1.1,8:00,21,22,21,21, --- ,21,21,22,21, --- ,21
 2005.1.1,9:00,35,30,23,35, --- ,23,35,30,23, --- ,23
 2005.1.1,10:00,40,30,23,40, --- ,23,40,30,23, --- ,23
 2005.1.1,11:00,40,37,28,40, --- ,28,40,37,28, --- ,28

2005.1.31,17:00,49,43,38,49, --- ,18,21,24,18, --- ,38
 2005.1.31,18:00,50,39,37,50, --- ,18,20,24,18, --- ,37
 2005.1.31,19:00,45,39,38,45, --- ,20,20,24,20, --- ,38
 2005.1.31,20:00,30,28,27,30, --- ,21,21,22,21, --- ,27
 2005.1.31,21:00,32,28,26,32, --- ,23,35,30,23, --- ,26
 2005.1.31,22:00,20,19,16,20, --- ,23,40,30,23, --- ,16
 2005.1.31,23:00,20,19,16,20, --- ,28,40,37,28, --- ,16
 2005.2.1,0:00,21,20,15,21, --- ,15,21,20,15, --- ,15



[Cautions]

View of data

It displays the power proportional distribution results of indoor unit No.1-00, from 0:00 to 1:00 on 1 January 2005.

PPD Hourly Data (Wh)										
Note:	Date and Time mean the calculation time of PPD.									
The value of 3:00 is a result between the calculation time just before 3:00 and 3:00.										
Date	Time	'1:1-00	'1:1-01	'1:1-02	'1:1-03	'1:4-15	'2:1-00	'2:1-01	'2:1-02	'2:4-15
2005.1.1	0:00	21	20	15	21	15	21	21	20	15
2005.1.1	3:00	22	20	17	22	17	22	20	24	19
2005.1.1	3:00	22	24	19	20	19	20	20	24	19
2005.1.1	4:00	20	21	19	20	18	20	21	24	19
2005.1.1	5:00	21	24	18	21	18	21	21	24	18
2005.1.1	6:00	20	24	18	20	18	20	24	24	18
2005.1.1	7:00	20	24	20	20	20	20	24	24	20
2005.1.1	8:00	21	22	21	21	21	21	21	22	21
2005.1.1	9:00	35	30	23	35	23	35	35	30	23
2005.1.1	10:00	40	30	23	40	23	40	40	30	23
2005.1.1	11:00	40	37	28	40	28	40	40	37	28
2005.1.31	17:00	49	43	38	49	18	21	24	24	18
2005.1.31	18:00	50	39	37	50	18	20	24	24	18
2005.1.31	19:00	45	39	38	45	20	20	24	24	20
2005.1.31	20:00	30	28	27	30	21	21	22	21	27
2005.1.31	21:00	32	28	26	32	23	35	30	23	26
2005.1.31	22:00	20	19	16	20	23	40	30	23	16
2005.1.31	23:00	20	19	16	20	28	40	37	28	16
2005.2.1	0:00	21	20	15	21	15	21	21	20	15

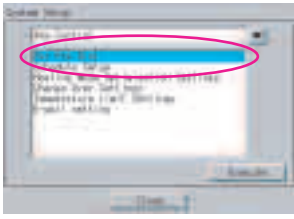
8. TROUBLESHOOTING

Symptom	Cause and counter measures
<p>"Pwr Prp Dist" is not displayed.</p> 	<p>Power Proportional Distribution function is not set yet. Contact your supplier.</p>
<p>When power proportional distribution calculation is carried out, the following message is displayed.</p> 	<p>There is a time zone when power proportional distribution calculation is not made in the designated collection period. The cause for non availability of power proportional distribution calculation can be power failure. Press OK button to continue collection. *Collection is made by other period excluding the day.</p>
<p>When Power Proportional Distribution Report is to be saved into a file, "No memory card" is displayed.</p>	<p>PCMCIA card is not inserted correctly into the intelligent Touch Controller. Check whether PCMCIA card is inserted, and whether it is inserted correctly or not.</p>
<p>I can't display electric power amount in unit of tenant.</p>	<p>When electric power proportional distribution is carried out by the intelligent Touch Controller mainframe, electric power amount is displayed in unit of air conditioner or in unit of zone. To display electric power amount in unit of tenant, edit the data of CSV format saved in PCMCIA card by use of your general purpose table calculation software.</p>
<p>How do I convert electric power amount into charges?</p>	<p>It is not available to convert electric power amount into charges by the intelligent Touch Controller. To convert electric power amount into charges, edit the data of CSV format saved in PCMCIA card by use of your general purpose table calculation software.</p>

Symptom	Cause and counter measures
How to print out Power Proportional Distribution Report?	The intelligent Touch Controller does not have printing function. To print out Power Proportional Distribution Report, print out the data of CSV format saved in PCM-CIA card by use of your personal computer and printer.
How to change zone registration?	To change zone registration for change of insertion and so forth in the middle of month, read out once Power Proportional Distribution Report for the days to the previous day of change. (By period designation, it is possible to designate and read an optional period.) For the month with change, read the reports for days before change and those for days after change.
Exclusion Periods (Normal Type) setup and Special Calculation Days (Normal Type) setup	Exclusion Periods (Normal Type) setup and Special Calculation Days (Normal Type) setup are not to be set when to carry out power proportional distribution of ice storage type. And setting is for only one pattern, and it is not available to make different setting per zone.
Electric power amount at stoppage	“Electric power amount at stoppage” in the display of Power Proportional Distribution Report is the total value of electric power amount when it is set not to proportionally distribute electric power of crank case heater consumed at stoppage of air conditioner since the electric power amount cannot be divided to any air conditioner. The electric power amount in this case must be handled as common service fees and so forth.
“Time Zone Setup” is not displayed.	“Time Zone Setup” can be displayed in SE Mode. Contact your supplier.
When the S button is pressed, “Password for administrator” is displayed. 	Confirm your administrator to enter the password.

9. AFTER-SALES SERVICE

After-sales Service

- **To have the product repaired, prepare the following information**
 - Model
 - Date of installation
 - Circumstances - as detailed as possible
 - Address, name, phone number
- **Transfer**
Transfer requires professional technique. Be sure to contact the supplier you purchased the product from or service station.
The customer will be charged for the expense required for transfer work.
- **Questions**
For after-sales service, contact the supplier you purchased the product from or the nearest service center.



Daikin Europe N.V. is approved by LRQA for its Quality Management System in accordance with the ISO9001 standard. ISO9001 pertains to quality assurance regarding design, development, manufacturing as well as to services related to the product.



Daikin units comply with the European regulations that guarantee the safety of the product.



ISO14001 assures an effective environmental management system in order to help protect human health and the environment from the potential impact of our activities, products and services and to assist in maintaining and improving the quality of the environment.



Daikin Europe N.V. participates in the Eurovent Certification Programme for Air Conditioners (AC), Liquid Chilling Packages (LCP) and Fan Coil Units (FC); the certified data of certified models are listed in the Eurovent Directory.

Specifications are subject to change without prior notice



DAIKIN EUROPE N.V.

Zandvoordestraat 300
B-8400 Ostend - Belgium
www.daikineurope.com